



Features

- ◇ For IF SAW filter
- ◇ High attenuation
- ◇ Single-ended operation
- ◇ Dual In-line Package
- ◇ No matching required for operation at 50Ω
- ◇ RoHS compliant (2002/95/EC), Pb-free

Specifications

Parameter	Unit	Minimum	Typical	Maximum	
Center Frequency	MHz	95.05	95.2	95.35	
Insertion Loss	dB	-	24.7	27	
3 dB Bandwidth	MHz	10.9	10.96	-	
40 dB Bandwidth	MHz	-	11.67	-	
Passband Variation	dB	-	0.7	1.5	
Absolute Delay	usec	-	3.43	4	
Ultimate Rejection	$f_0 \pm 5.85\text{MHz}$	dB	35	43	-
	$f_0 \pm 6.05\text{MHz}$	dB	45	58	-
	$f_0 \pm 6.45\text{MHz}$	dB	50	56	-
	$f_0 \pm 10.45\text{MHz}$	dB	55	60	-
Material Temperature coefficient	KHz/°C	-8.95			
Substrate Material	-	YZ LN			
Ambient Temperature	°C	25			
Operating Temperature Range	°C	-40	-	+85	
Storage Temperature Range	°C	-45	-	+105	
DC Voltage	V	0			
Input Power	dBm	-	-	10	
ESD Class	-	1A			
Package Size	DIP3512 (35.0x12.8x4.7mm3)				

Notes:

1. All specifications are based on the test circuit shown;
2. In production, all specifications are measured by Agilent Network analyzer and full 2 port calibration at room temperature;
3. Electrical margin has been built into the design to account for the variations due to temperature drift and manufacturing tolerances;
4. This is the optimum impedance in order to achieve the performance show.

	SIPAT Co., Ltd. (CETC No.26 Research Institute) #14 Nanping Huayuan Road, Chongqing, China, 400060	Part Number	LBN09508	
		Rev. Date	2008-07-31	
		Ver.	1.0	Page

Matching Configuration



Source/Load Impedance=50 ohm

Notes - Component values may change depending on board layout.

Package Dimension

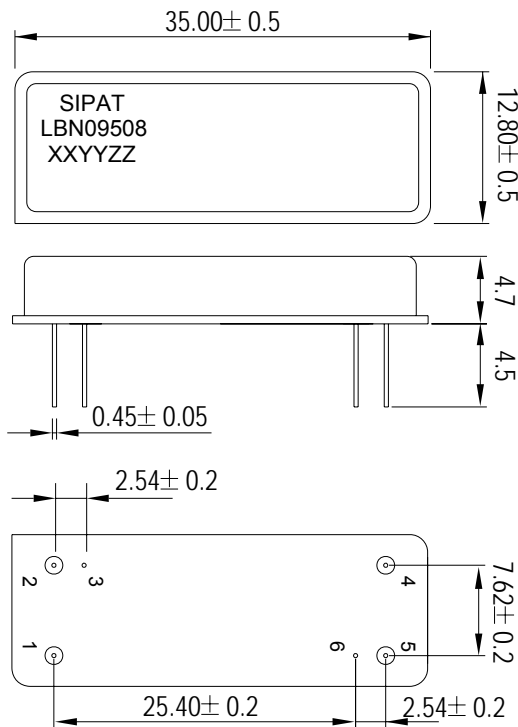

Pad Configuration:

Input 1
Output 5
Ground All Others

Marking Configuration:

- 1) SIPAT: Manufacturer Name
- 2) LBN09508: Part Number
- 3) XXYY: Date(Year/month)
- 4) ZZ: Identified Code

Package: DIP3512

Unit: mm



SIPAT Co., Ltd.
(CETC No.26 Research Institute)
#14 Nanping Huayuan Road,
Chongqing, China, 400060

Part Number	LBN09508	
Rev. Date	2008-07-31	
Ver.	1.0	Page 2/3



Typical Performance

Frequency Respond

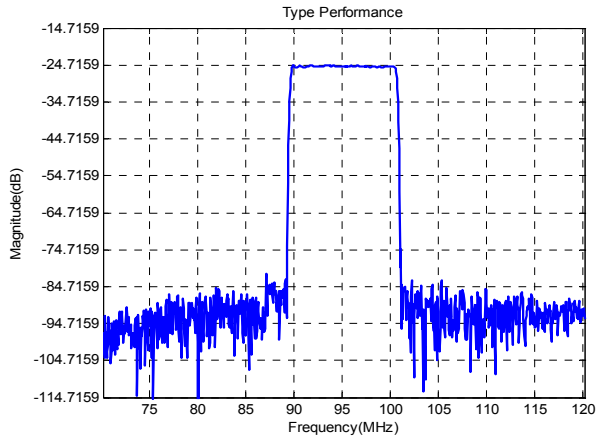

Horizontal: 5MHz/Div Vertical: 10dB/Div

Passband Respond

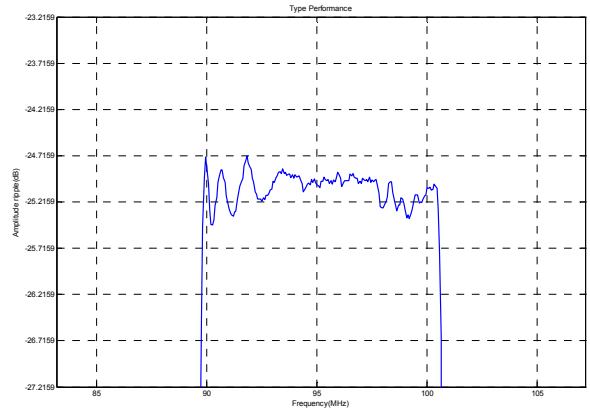

Horizontal: 5MHz/Div Vertical: 0.5dB/Div

Group Delay Variation($f_0 \pm 5\text{MHz}$)

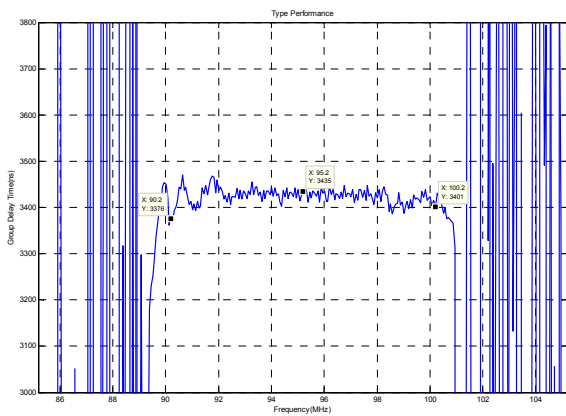

Horizontal: 2MHz/Div Vertical: 100ns/Div

Phase Linearity($f_0 \pm 5\text{MHz}$)

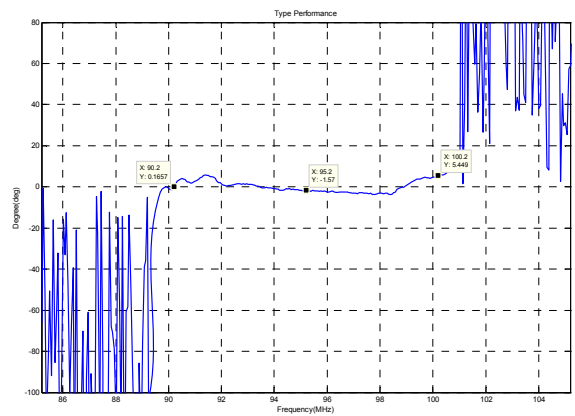

Horizontal: 2MHz/Div Vertical: 20deg/Div

Smith Chart S11

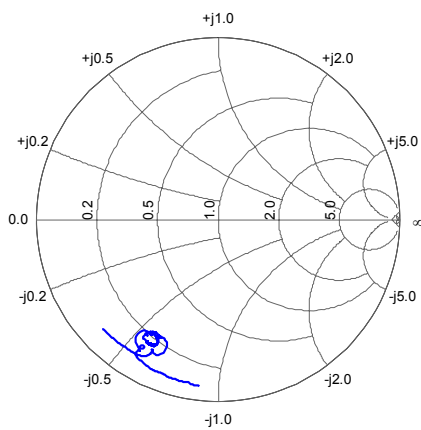

Smith Chart S22

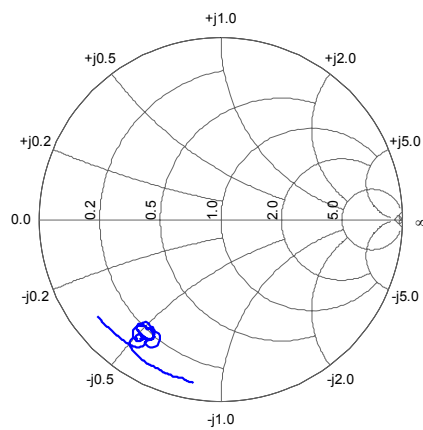

SIPAT Co., Ltd.
(CETC No.26 Research Institute)
#14 Nanping Huayuan Road,
Chongqing, China, 400060

Part Number	LBN09508	
Rev. Date	2008-07-31	
Ver.	1.0	Page 3/3